



WOW

AMAZING ELECTRIC

WOW774 – WOW775  
USER MANUAL



We would like to thank you for choosing a **WOW 774-775** scooter.

In order to maintain the scooter always in perfect status of efficiency, we recommend to read and follow carefully the instructions contained herein.

In this manual you will find some detailed information on how to use and maintain your **WOW 774-775**.

So that the warranty conditions do not lapse, we invite you to contact only **WOW** Authorized Workshops and ask for original **WOW** spare parts. For all information regarding your **WOW 774-775** guarantee we recommend to read carefully the warranty booklet. The updated version of this Use and Maintenance Manual is always available on the website: [www.wowescooter.com](http://www.wowescooter.com).



Ask always for **WOW** Original Spare Parts. Only purchasing **WOW** Original Spare Parts you will receive a qualified technical assistance you will appreciate for reliability, performance and a constant safety along the time.

**WOW!** S.r.l. declines any responsibility for mistakes in which it may have incurred in filling this manual and it reserves the right to make any change required by its product development. **WOW!** S.r.l. reserves the right to make technical and aesthetic, or other modifications without any further forewarning.

Version N1



---

1	Scooter identification and details	pp. 5-7
2	Controls	pp. 8-12
3	Use of scooter and main functions	pp. 13-25
4	Lithium-ion batteries utilization warnings	pp. 26-28
5	Driving safety	pp 29-33
6	Checkup and maintenance	pp. 34-44
7	Accessories utilization warnings	p. 45



## SCOOTER IDENTIFICATION AND DETAILS

The vehicle identification number (VIN) or frame number is located on the right side, under the passenger footrest and on the rear shock absorber (see picture in detail). Check the reported VIN matches with the present one in the vehicle registration document and on the warranty card. Enter your scooter's VIN below.



### Vehicle Identification Number

--	--	--	--	--	--	--	--	--	--	--	--	--	--	--	--	--	--	--	--

### SCOOTER IDENTIFICATION AND DETAILS



- 1 Underseat compartment
- 2 Rear brake lever (774 Model) - Combined braking lever (775 Model)
- 3 Battery charging socket
- 4 USB charging port for Smartphone / Electronic Devices
- 5 Left passenger footrest
- 6 Side stand (optional)
- 7 Central stand
- 8 Rear taillight and direction indicator
- 9 Left battery

## SCOOTER IDENTIFICATION AND DETAILS



- 10 Front brake lever
- 11 Front headlight
- 12 Front brake disc
- 13 Ignition lock
- 14 Bag hook
- 15 Right passenger footrest
- 16 Right battery
- 17 Rear brake disc

## CONTROLS

### Remote control – Scooter keys

The scooter is supplied with two copies of a remote control key which serves as:

- keyless start switch
- underseat compartment opening

Keep the copy of the key separately.

- Ignition scooter's button (1)

Once pressed, one beep will be heard and the scooter will turn on by its ignition lock.

- Vehicle turn off key (2)

Once the vehicle is turned off, the immobilizer alarm will go off (in case of vehicle displacement such a system will emit a beep sequence).

- Passenger seat opening button (press for at least 3 seconds) for batteries removal (3)

- Into the remote control is included a "mechanical" key (4) - to use in case remote control / vehicle batteries are flat.

- The mechanical key must be inserted in the ignition lock by sliding the specific flap shown in the picture. Once the front seat has been unlocked, it can be used to mechanically unlock the rear seat through a dedicated lock placed between the two seats.

Please Note: The mechanical key has to be used also in case of absence of on-board batteries to open the compartment under the seat and to insert the batteries into their housing when the rear seat is closed.

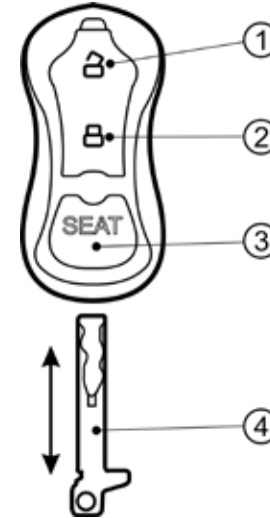

Press down to remove the mechanical key

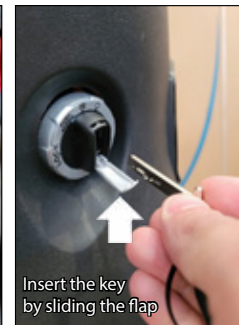

Insert the key by sliding the flap

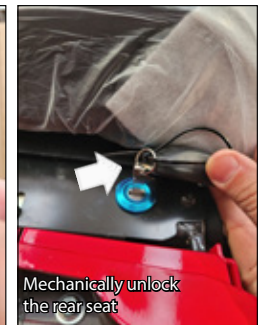

Mechanically unlock the rear seat



## CONTROLS

### Dashboard

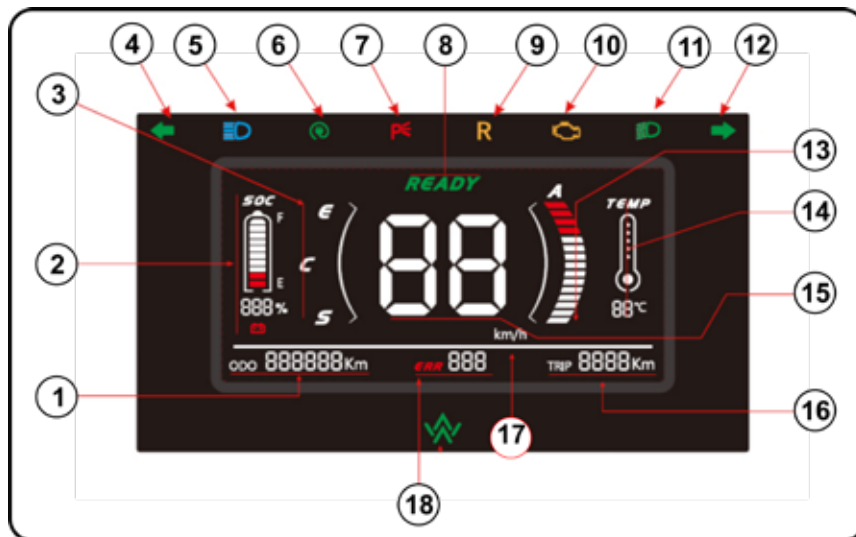

## CONTROLS

1	Odometer	It indicates total kilometers traveled.
2	Battery indicator /charging status	It indicates battery charge / vehicle range (SOC) percentage.  E = this map is more oriented towards battery energy saving with a good balance among maximum speed, acceleration and power consumption.
3	Map indicator in use	C = this map provides, always looking for a suitable battery power saving, a strong acceleration at the start. Mainly suited to urban paths.  S = this map provides the best performance during acceleration and the maximum speed.
4	Left direction indicator	It indicates that left direction indicator is working.
5	High beams	It indicates that high beams are on.
6	Battery recharging	It indicates the vehicle batteries are currently on charge.
7	Parking mode	Available only with the Sharing version.
8	Vehicle READY status	It indicates that vehicle is on and ready for departure; by turning the throttle handle, the rear wheel will come in function.
9	Reverse gear	It indicates the “reverse gear” button on the left handlebar is pushed; by turning the throttle grip the vehicle will reverse.
10	Vehicle default	Proceed cautiously and carry the vehicle to a service network.
11	Dipped headlights	It indicates that dipped headlights are on.
12	Right direction indicator	It indicates that right direction indicator is working.
13	Engine power request indicator	It indicates the required energy amount depending on our riding habit.
14	External temperature indicator	It indicates the external temperature.
15	Speed indicator / Speedometer	It indicates the current speed expressed by Km/h.
16	Odometer	It indicates the trip distance covered. It can be reset by the button positioned on the right handlebar.
17	Speedometer measurement unit	It indicates the unit of measurement for speed and distance traveled.
18	Failure code indicator	Depending on which code has shown, it indicates the kind of vehicle failure (Call for WOW! Assistance).

## CONTROLS

### Control functions

#### Ignition Lock

The respective function positions are as follows:

**OFF:** the vehicle is off, lights are off and if you turn the throttle grip the scooter doesn't move (Figure 1).

**ON:** After pressing the "open padlock" button on the remote control, the scooter and the lights can work (Figure 2).

**LOCK:** By turning without pressing the ignition switch on **LOCK** position, the driver's seat opens.

By switching the ignition switch on **LOCK** position and pressing the turning part, the mechanical steering lock is activated. The engine and lights cannot still run (Figure 3).

**Beware** 

Always lock the steering when the scooter is parked to avoid unauthorized use.

**Beware** 

After the locking, try to gently turn the handlebar to make sure the steering is actually locked.

Always unlock the steering before letting the vehicle off the stand.

The ignition switch automatically blocks in few seconds after it has been set on **OFF** position. For security, by pressing the "padlock closed" button on the remote control, the lock blocks instantly.



1



2

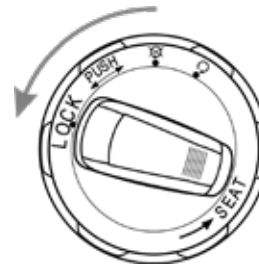

3

## CONTROLS



- 1 High beam / dipped headlight switch
- 2 Direction indicators button
- 3 Horn button
- 4 Reverse gear activation button
- 5 Vehicle ON / OFF switch (in case of danger as an emergency shutdown of the vehicle)
- 6 Engine map selector
- 7 Trip odometer reset button
- 8 Electromagnetic brake button allowing energy recharge

## USE OF SCOOTER AND MAIN FUNCTIONS

### Underseat Compartment Opening

The vehicle is equipped with an undersaddle compartment. To open the rider seat (for reach the compartment) turn the ignition switch anticlockwise towards the word **LOCK** without pressing (after pressing the “open padlock” button on the remote control).

**Beware** 

Maximum load allowed is 10 kg.

Make sure to close the seat correctly before using the scooter.

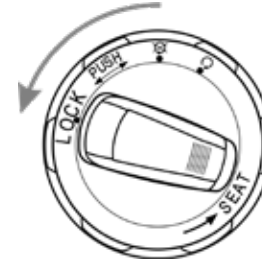

## USE OF SCOOTER AND MAIN FUNCTIONS

### Bag hook

The scooter is equipped with a bag hook for small light luggage carriage.

In order to use it, hang the bag handle on the dedicated hook (2).

### Beware



Maximum load allowed is 3 kg.

### 5 V socket

The scooter is equipped with a 5 V socket for Smartphone charging by a USB port (1).

- Insert the plug of the battery charger into the dedicated USB port after removing the protection cap.

### Beware



- In case of non-use remember to apply the dedicated plug to the socket.
- Read carefully the charging instructions and technical specifications of your phone before insert the charging cable into its port, so as not to damage it. Any damage caused to the battery charger is not covered from guarantee.



## USE OF SCOOTER AND MAIN FUNCTIONS

### Central stand

To put the scooter on central stand, by doing lever with one foot on the stand, move the scooter holding the passenger handle with the right hand while with the left hand keep the handlebar, turning it to the left.

### Beware



- To prevent accidents make sure the central stand is fully retracted before departure.
- Make sure that the stand spring is working fine, to prevent the central stand from lowering while driving, causing accidents.



## USE OF SCOOTER AND MAIN FUNCTIONS

### Side stand (optional)

Use side stand on firm and flat ground only for short stops.

### How to use it

- Turn off the scooter and get down of it.
- Extend side stand and rest the scooter on it.
- Turn completely the handlebar to the left and make sure the scooter remains stable.
- When the side stand is pulled out the word READY won't appear on the dashboard and the scooter cannot move forward. (see indications and instructions on the dashboard at page 9).

### Beware



In order to prevent accidental bumps from dropping your scooter, do not leave it on side stand on transit areas.

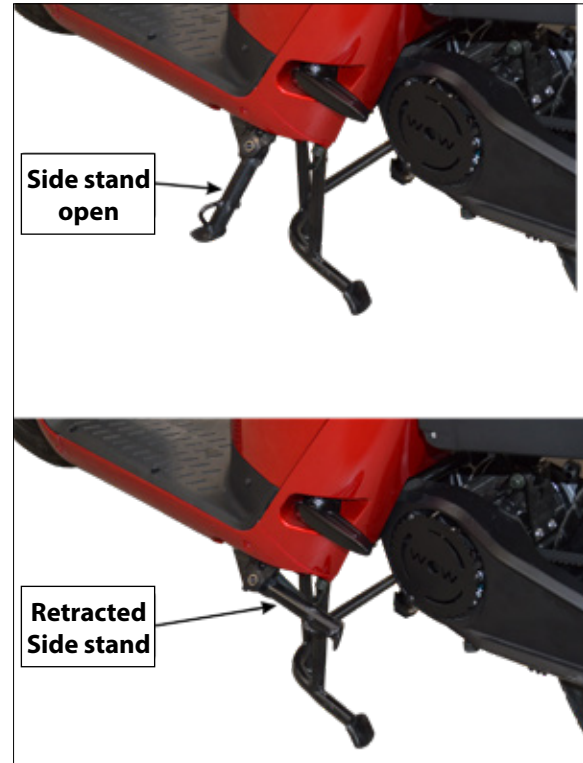



### USE OF SCOOTER AND MAIN FUNCTIONS

#### Passenger footrest

The scooter is equipped with retractable rear footrests for a passenger.

To extract the passenger footrests press them inwards.

If you are traveling without a passenger, press the footrests towards their housings until you hear a lock click to keep them in an idle position.



### USE OF THE VEHICLE AND MAIN FUNCTIONS

#### START-UP

On the remote control press the “open padlock” button (1) by turning clockwise the ignition switch to “ON”.

To proceed with the scooter advancement throttle gently.

#### Beware



Before ignition, put always the scooter on central stand.

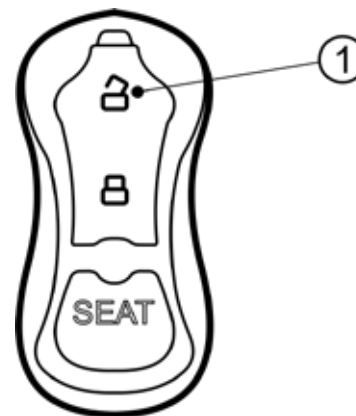

## USE OF THE VEHICLE AND MAIN FUNCTIONS

### Increase the speed smoothly

To put the scooter in motion, release brake lever and turn the throttle grip slightly.

### Beware

In order to keep scooter control, increase speed gradually. The speed is regulated by the throttle control.

### Turn (1) The speed increases

- At start or approaching an uphill road, turn the grip gradually to increase the power delivered from the engine.

### Turn back (2) The speed decreases

- In case of braking or emergency, the grip turn back must be carried out as much quickly as possible.



### Drive carefully

Before taking the road switch on the direction indicators and check for the arrival of no other vehicles.

## USE OF SCOOTER AND MAIN FUNCTIONS

### Brake management

For scooter best control operate the levers brake gradually, at first slightly then gradually more intensely, depending on need. While braking, brake light comes on to warn following vehicles.

### Beware



Using only one brake can make the scooter slip. Always use both brakes.

### Avoid hard braking or sudden swerves

If abruptly used, brakes can cause a wheel block and lead to a dangerous situation. Abrupt braking and sudden swerving can cause slipping.

### Make attention on wet roads

Grip on wet road is less than on a dry one and the braking distance increases. Decrease the speed and pay a close attention.

**WOW 775** model is equipped with a combined braking system. Left lever acts on front brake while the right lever acts on both brakes (front and rear).

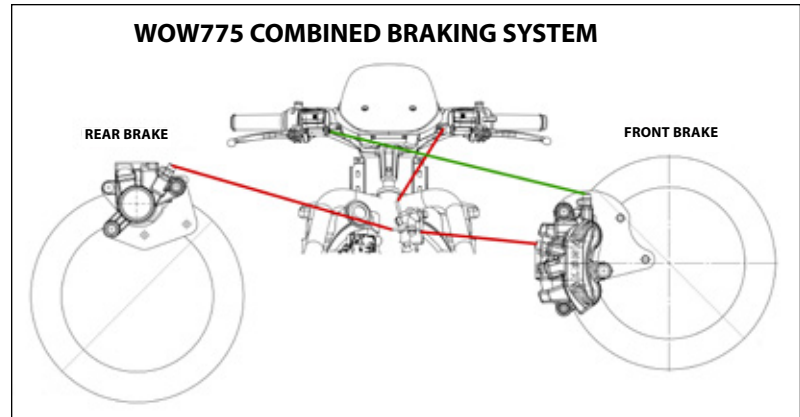

## USE OF SCOOTER AND MAIN FUNCTIONS

### PRE-DRIVE CHECKUP

It is good habit to perform a scooter quick inspection before riding.

This daily check, in addition to be crucial for safety, can prevent vehicle damage.

If any anomaly is found, call as soon as possible for a **WOW** assistance.



## USE OF SCOOTER AND MAIN FUNCTIONS

### CHECK THE VEHICLE BATTERY CHARGE STATUS

#### SOC (State of Charge):

Before using your **WOW** scooter verify the battery charge status equipping your vehicle; in case the dashboard control indicates that charge percentage is low proceed to batteries recharge before departure.

#### Beware:



Battery charge level indicator requires from 10 to 15 charging cycles to carry out for reach an optimal reliability.



### In case of prolonged inactivity of the scooter, it is necessary to proceed as specified below:

- Check the status of the charge of the batteries and, if they are at a charge level of less than 20%, proceed to charge them (the monthly self-discharge is included in a range that varies from 1,5% and 3% depending on temperature /humidity conditions)
- Before proceeding to reactivate and use the scooter, remove both batteries from their cases for 10-15 seconds and then reinsert them to be automatically reactivated.

### BATTERIES RECHARGE

Wow scooters are equipped with two batteries that work in series. This means that the scooter can only work with both batteries installed on board. Even the recharging of the same must be done simultaneously.



## USE OF SCOOTER AND MAIN FUNCTIONS

### BATTERIES RECHARGE

To proceed with a battery recharging, it is necessary to adopt the supplied battery charger, equipped with a cooling fan and a Schuko socket connection. The **WOW** scooter can recharge the supplied batteries as follows:

### BATTERIES INSTALLED ON THE VEHICLE

#### CASE 1 : BLUE COLOR CONNECTOR IN THE BACKSHIELD

- 1) Turn off the scooter using the switch – steering lock by turning it to the “OFF” position.
- 2) Connect the recharge cable supplied with the scooter via the recharge socket located on the rear part of the front shield (blue connector).
- 3) Connect the battery charger to the home electricity supply.
- 4) When the vehicle is on, the green icon @ will appear on the dashboard.
- 5) The charger has 1 LEDs:

**LED off** : the charger is not connected to the electricity grid.

**Green LED**: the charger has fully recharged the batteries and the vehicle can be used.

**Red LED**: the charger is charging the batteries, the full recharge has not yet been reached.

The vehicle is considered perfectly recharged and the batteries balanced when the LED is Green on the charger, and the icon @ on the dashboard is off.

Please note : always check that the plugs are fully inserted into the battery charger.

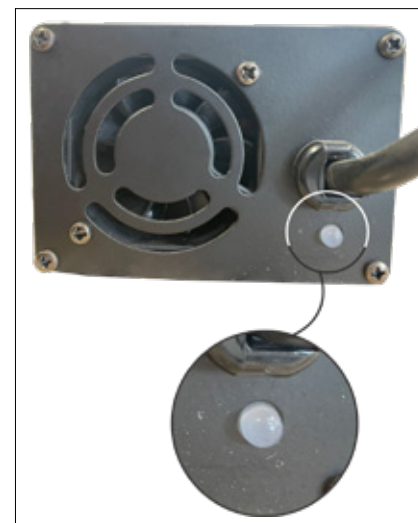

## USE OF SCOOTER AND MAIN FUNCTIONS

### BATTERIES INSTALLED ON THE VEHICLE

#### CASE 1 : BLACK COLOR CONNECTOR IN THE BACKSHIELD

- 1) Turn off the scooter using the switch – steering lock by turning it to the “OFF” position.
- 2) Connect the recharge cable supplied with the scooter via the recharge socket located on the rear part of the front shield (black connector).
- 3) Connect the battery charger to the home electricity supply.
- 4) When the vehicle is on, the green icon @ will appear on the dashboard.
- 5) The charger has 4 LEDs:

**Led offs :** the charger is not connected to the electricity grid.

**4 red LEDs:** the charger is charging the batteries, the full recharge has not yet been reached.

#### **2 red LEDs and 2 green LEDs :**

the charger has fully recharged the batteries and the vehicle can be used. The vehicle is considered perfectly recharged and the batteries balanced when there are 2 green LEDs and 2 red LEDs on the charger, and the icon @ on the dashboard is off.

Please note : always check that the plugs are fully inserted into the battery charger.





## USE OF SCOOTER AND MAIN FUNCTIONS

### A and B BATTERIES RECHARGE REMOVED FROM THE VEHICLE USING A "REFILL BASE"

- 1) To remove batteries from the scooter open the driver seat by turning the ignition lock as shown at page 13.
- 2) On the remote control press for 3 seconds the **SEAT** button
- 3) In order to unlock battery locking system from its own position remove passenger seat from its housing (eventually, rise slightly the plastic cover compartment for an easy release).
- 4) Remove batteries from their housings.

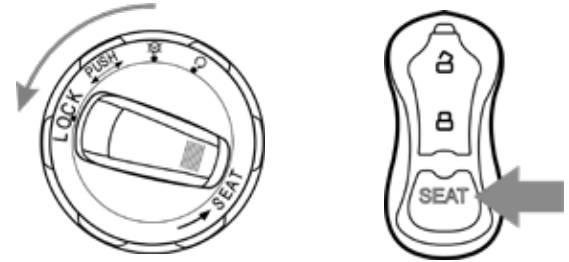

Proceed to batteries recharge by putting them in the battery holder (supplied on request) and connecting it to the battery charger supplied with the scooter.

In order to verify the battery status charge and the charging procedure, proceed as indicated in the section **“BATTERIES RECHARGE STILL INSTALLED ON THE VEHICLE”**.

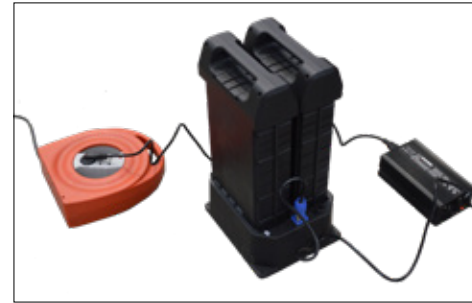

## LITHIUM-ION BATTERIES UTILIZATION WARNINGS

**WOW** owns the best quality lithium-ion batteries. These batteries detain a complex technology and their performance depends on a number of circumstances, which can affect **WOW** scooter performances.

All rechargeable batteries have their own life cycle and their capacity and performances decrease over time, due to aging. To ensure the best performance and minimize **WOW** batteries aging, it is required to be aware of some simple rules described herein, which are valid also for all other lithium-ion batteries.

### Batteries Maintenance

A lithium-ion battery remains in a healthy state when it is constantly used: therefore keep it in a functioning status with charge / discharge cycles at least weekly. If you plan not to use it for a while, disconnect the battery from the scooter and store it in a cool place with a state of charge preferably between 40% and 60%. Please remind that battery non-use will lead to a premature aging, in case of a very high (above 85%) or very low charge (below 20%). Please also remind that if you do not use the battery, it will age prematurely above 35° C of temperature.

If you plan not to use it for more than two weeks, remember that the battery is subject to a normal phenomenon called self-discharge. The battery charge will being reduced by about 3-4% every month, also considering integrated electronic circuits consumption. Due to self-discharge, try to prevent that the charge, during the period of non-use, falls below 20%. Self-discharge will be higher in the presence of high temperatures; for that reason storage must be done in a cool place with a temperature lower than 25° C.

Do not overheat batteries. The main enemy of a lithium-ion battery is heat which leads it to faster aging. When about 45° C are exceeded, battery aging becomes faster. The more time the battery remains above that temperature or higher, the greater will be the damage.

## **Battery charging and discharging**

During the use, it is better to prevent a battery full discharge. It is preferable do not discharge the battery below 15-20% (Low Battery). Excessively low charge status can lead a battery chemical / thermal stress and a premature aging. It is therefore useless and strongly not recommended to reach 0%, also because lithium-ion batteries do not suffer from a battery memory effect. The use optimal threshold is therefore with charge status higher than 15%.

Lithium-ion batteries prefer short and frequent charge / discharge cycles instead of full charge / discharge from 0% to 100%. From a theoretically point of view, the longer battery life span should be obtained with charge / discharge cycles between 35% and 90%. All of that is not always practically feasible and very often the charge cycle leads the battery to 100% of charge. The ideal would be whether the batteries would remain at a maximum voltage time as a short time as possible; for that reason it would be preferably a batteries recharge to 100% just before their utilization. Likewise, try to upload the batteries frequently (for example when they reach a minimum of 50% of charge), without waiting for too long.

## **Winter and low temperatures**

Winter and low temperatures drastically reduce all lithium-ion batteries charge and discharge capacity. The battery capacity reduction can reach 35%. This is a well known phenomenon having nothing to do with battery decay. Indeed, with the return of the hot season, autonomy tends to rise again.

During charging, a low temperature significantly reduces the battery's ability to store energy. During a charge carried out at a temperature lower than 10° C, due to chemical phenomena increasing the internal battery resistance, even if the indicated charge is about 100%, in practice the battery will have stored a smaller amount of energy. Before charging, if possible, it is better to maintain the battery to a temperature of at least 20° C.

During discharge, a low temperature causes an increase of battery resistance. The energy request for a battery with high resistance will result in a greater voltage drop, mainly in case of a low status of charge. For that reason, during the winter is preferable to use the battery with a charge status higher than 45-50%. Under these values it is quite normal to observe a performance and autonomy decrease.

It is recommended prevent batteries usage when it is very cold, below 0° C. The sudden heating that occurs when using a cold battery can lead to localized internal overheating and consequent damages.

## RECHARGING MODE

The **WOW** electric scooter you have purchased is equipped with a Schuko socket connection charging device (charging mode Type 1: CEI 23-50 - CEI EN 60309-2).

For safe operation, Type 1 charging point must depend on the presence of plant-side specific protections: protection against over-currents, electric grounding system, and protection against contacts.

Currently, the standard containing required prescriptions of electric vehicles recharge with on-board batteries is the CEI EN 61851-1: 2012-05. It should be noted that the Italian edition of the European standard in force contains the following assumption: "... in Italy, the charging mode Type 1 is allowed only in strictly private areas not open to third parties, such as for example environments whose access requires keys, special tools, etc., in the sole possession of the owner".

On the basis of the current legislation, the electric scooters' recharge with on-board batteries using a Schuko socket connection is allowed exclusively inside private houses and garages to which access is limited (by a way of example and not limited to villas, independent houses, private garages); are de facto excluded common buildings, remittances and public and/or condominium garages).

**WOW!** S.r.l. declines any responsibility of non-compliance with the aforementioned regulations.

Otherwise, when the batteries are recharged using the appropriate charging base, thus outside and separately from the vehicle, the regulatory obligations mentioned in the previous paragraphs lapse.

## DRIVING SAFETY

### DRIVING SAFETY

To drive safely, relax and wear clothes with adequate protections.

Respect the road traffic rules; keep concentration while riding, as being cautious is essential to prevent accidents.

Healthy physical conditions are essentials for better control of the vehicle.

Medicines, drugs of abuse and alcohol make driving risky.

**Beware** 

Before riding the scooter, carry out pre-driving checks.

### Equipment

Always wear appropriate clothing. Put on the helmet and fasten it correctly.

It is advisable to use protective gloves, specific for motorcycle. Handlebar must be held firmly using both hands.

It is very dangerous to ride the scooter using only one hand.

**Beware** 

In order to prevent dangerous situations of driving, avoid wearing clothes that are too loose or too long.



## DRIVING SAFETY

### DRIVING METHOD

Sit in a correct position that allows the control of all scooter functions.

Two-wheeled vehicles safety is affected by driving position. The rider must occupy the central part of the saddle. A position that is too far back causes a lightening of the front wheel that can lead a scooter skid.

Avoid abrupt maneuvers that could cause scooter control loss. Pay close attention to road conditions. In case of roads with potholes and surface undulations, decrease the speed.

### **Beware**

Handlebar must be held firmly using both hands, as required by the traffic rules. In fact, it is very dangerous to ride the scooter using only one hand.

### **Luggage**

Vehicle behavior changes when objects are carried on. Excess in loading can cause steering swingings and compromise a safe driving.

### **Beware**

In order to avoid for accidents or bodywork damage, do not carry objects outside the provided compartments.

## DRIVING SAFETY

### PASSENGER TRANSPORTATION

For the transport of a passenger use exclusively the seat rear part.

Please remind that the driver has the responsibility to aware the passenger on how to get on e getting off the vehicle. Furthermore, in order to adjust the vehicle stability and balance, the rider has to be the first to get on and the last to get off the vehicle.

### Passenger boarding

The rider, after getting on the vehicle, keeps both feet on the ground in order to maintain the vehicle in balance.

### Descent

The rider, after stopping the vehicle, keeps both feet flat on the ground in order to maintain the vehicle in balance.



## DRIVING SAFETY

### Decrease downhill speed

Downhill, release the throttle grip and reduce the speed while making intermittent slight brakings.

### Beware



Avoid prolonged brakes' utilization, which causing the elongation of braking distance, as they can overheat and loss of efficiency.





## DRIVING SAFETY

### How to stop

#### 1 – Approaching the stop point

Activate direction indicators, verify no other vehicles are coming and stop the scooter smoothly. To stop, release the throttle grip and brake smoothly using both of brakes.

2 - When the vehicle is stationary, deactivate direction indicators and turn the ignition lock to “OFF” (vertical position) to turn off the vehicle.

### Parking

Get off the scooter.

With the left hand hold firmly the handlebar, while with the right hand grab the passenger handle. With your right foot lower the central stand, while at the same time pull the scooter back, using both of your hands. Always park the scooter on flat ground and in position such as not to obstruct traffic. The scooter may fall if parked on uneven or yielding surfaces.

### Lock the steering

To insert the steering lock, turn the steering to the left and turn ignition lock counterclockwise, making sure the steering is effectively locked.



### CHECKUP AND MAINTENANCE

#### Belt Drive

Before using the vehicle it is recommended to verify belt drive wear condition and its correct tensioning simply by turning belt drive upper part.

Belt drive must achieve a maximum twisted angle of  $120^\circ$ . If inspection found a wider angle, we recommend proceeding to our service network for a correct belt tensioning check and verification.

#### Beware



No noises should be heard with proper belt drive adjustment.



## CHECKUP AND MAINTENANCE

### Throttle Control

Check that the opening of throttle is rotating well and the overall self-rotation to the back could be done in all steering positions.

### Beware



Failure of self-turn back of throttle grip can lead to dangerous situations and falls.

### Steering control

Move the handlebar forward, backward, to the right and to the left, verify that there are no swings or parts not correctly fastened. Check that the steering rotates freely. If any anomaly is found, contact a **WOW** workshop for assistance and verification.

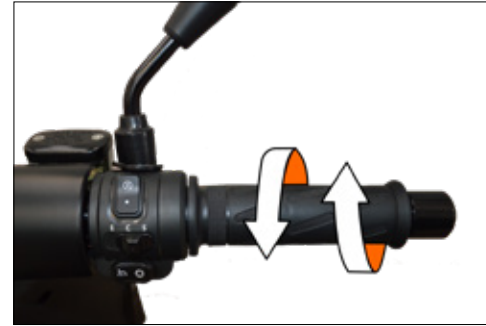

## CHECKUP AND MAINTENANCE

### Shock Absorbers Checkup

Check the shock absorber condition and its hydraulic fork by repeatedly pushing down the handlebar and the seat.

Verify that the shock absorber is not too much yielding and not very progressive.

Pay attention for any abnormal noises.

### Brakes control

Front and rear disc brake fluid level.

- Keep handlebar in horizontal position e verify the tank liquid level is between the maximum and minimum, as shown in the image.

- If tank level is close to the minimum, check visually brake pads wear. If pads are not worn there could be some leaks in the hydraulic circuit. Contact as soon as possible a **WOW** workshop for inspection.

For possible replacement and/or a topping up of front and rear brakes liquid (**DOT4**) please contact for a specialized **WOW** workshop



## CHECKUP AND MAINTENANCE

### Brake Pad Wear Inspection

Visually check pads' wear status. Pads must be replaced if the wear status indicators are not visible anymore.

#### Beware



- For a brake pads replacement, please contact an authorized **WOW** workshop.
- In order to adjust the profile of braking material to the disc, after a brake pads replacement, repeatedly activate the brake lever.
- After brake pads replacement it is necessary to proceed carefully, braking gradually and carry out a short run-in to achieve best performances and travel safety.

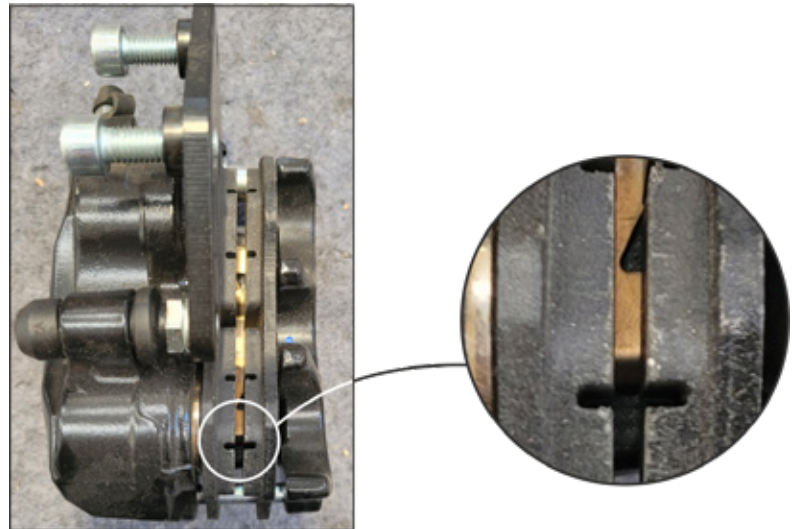

## CHECKUP AND MAINTENANCE

### Stop light checkup

- Turn the key "ON".
- Pull alternately right and left brake lever and verify that the rear brake light is working.
- Check also the rear light working-on.

### Headlight adjustment

- It is possible to adjust the front light beam inclination by using a size 3 hexagonal wrench, going to act on a dedicated position located in the lower right part of headlight (fig. 2).

### Direction indicators checkup

- Turn the key "ON".
- Activate the indicators control and verify that left and right arrows are flashing.

### Rearview mirror control

In order to achieve a proper rear view, sit on the saddle and adjust the mirrors.



Figure 2

## CHECKUP AND MAINTENANCE

### Tire Verification

Check the pressure with a pressure gauge. The measurement must be carried out when the tire is cold.

### Tire Pressure

- Check that inside the tire treads do not remain metal fragments, nails or gravel.
- Verify the state of wear.
- Replace the tire if it shows excessive or uneven wear.

### Beware



Incorrect pressure, excessive and uneven tire wear reduce vehicle stability and lead to early tire damage.

 <b>⚠ ATTENZIONE</b>			<b>⚠ PLEASE NOTE</b>	
<ul style="list-style-type: none"> <li>● Controlla le condizioni degli pneumatici prima di metterti alla guida</li> <li>● Sostituisci gli pneumatici usurati o danneggiati solo con pneumatici della stessa misura</li> <li>● Consulta il manuale di uso e manutenzione per ulteriori informazioni</li> </ul>			<ul style="list-style-type: none"> <li>● Check tires condition before driving</li> <li>● Replace worn or damaged tires only with tires of the same size</li> <li>● See the use and maintenance manual for further information</li> </ul>	
PRESSIONE / PRESSURE	 <sub>1</sub>	 <sub>2</sub>		MISURE / SIZES
ANTERIORE / FRONT	2.2 BAR	2.2 BAR	ANTERIORE / FRONT	100/80-R16
POSTERIORE / REAR	2.2 BAR	2.5 BAR	POSTERIORE / REAR	120/80-R16

## CHECKUP AND MAINTENANCE

### Light Control

While the scooter is ignited, verify front and rear lights, main beam headlamp and low beam, and the license plate light correct functioning. Please check also that lights are not damaged or dirty.

### Odometer Check

Verify that odometer and speedometer are correctly working.

### Horn Control

Turn the key “ON”, press the horn button and check its correct functioning.

### Overall Control

Inspect the scooter and verify for apparent damage to mechanical components and make sure there are no abnormal noises.

	RICORDA	PLEASE REMEMBER
	<ul style="list-style-type: none"> <li>• INDOSSA SEMPRE IL CASCO</li> <li>• LEGGI CON ATTENZIONE IL MANUALE D'USO E MANUTENZIONE PRIMA DI METTERTI ALLA GUIDA</li> <li>• RISPETTA LA NATURA</li> <li>• GUIDA CON PRUDENZA</li> </ul>	<ul style="list-style-type: none"> <li>• ALWAYS WEAR A HELMET</li> <li>• READ THE USE AND MAINTENANCE MANUAL CAREFULLY BEFORE DRIVING</li> <li>• RESPECT NATURE</li> <li>• DRIVE CAREFULLY</li> </ul>



## CHECKUP AND MAINTENANCE

### Periodic Maintenance

- To ensure safe and comfortable driving it is necessary to perform the above mentioned and illustrated periodic maintenance operations.
- When the scooter is not used for a long period of time, when putting it back into gear it is necessary to carry out an overall verification.
- It is further recommended to perform the first inspection according to the specified periodicity in the following maintenance table, or within the first month.

### Beware



- Pay most attention to personal safety during maintenance procedures.
- Put the scooter on its central stand and on a flat surface.
- Use suitable tools for the intended purposes.

### Screw tightening

Periodically check the tightness of the screws.





## MAINTENANCE TABLE WOW 774-775

YEARS	1	2	3	4	5	6	7	8	9	10
KM TRAVELED	1000	3000	6000	9000	12000	16000	20000	24000	28000	32000
SCREW TIGHTENING	C	C	C	C	C	C	C	C	C	C
STEERING BEARINGS	A	C	C	C	C	C	C	C	C	C
WHEEL BEARINGS	C	C	C	C	C	C	C	C	C	C
TIRE PRESSURE	C	C	C	C	C	C	C	C	C	C
BRAKES	C	C	C	C	C	C	C	C	C	C
BRAKE OIL	C	R	C	R	C	R	C	R	C	R
FRONT BRAKE HOSE	C	C	C	C	C	C	C	C	C	C
FRONT BRAKE PADS WEAR	C	C/R	C/R	C/R	C/R	C/R	C/R	C/R	C/R	C/R
REAR BRAKE PADS WEAR	C	C/R	C/R	C/R	C/R	C/R	C/R	C/R	C/R	C/R
ENGINE /CONTROL UNIT	C	C	C	C	C	C	C	C	C	C
REAR WHEEL SUSPENSIONS	A	C	C	C	C	C	C	C	C	C
CENTRAL / SIDE STAND	C	C	C	C	C	C	C	C	C	C
HEADLIGHT ADJUSTMENT	A	C	C	C	C	C	C	C	C	C
BELT DRIVE	C	R	R	R	C/R	C/R	C/R	C/R	C/R	C/R
BELT TENSIONER	C	C	C	C	C	C	C	C	C	C
BATTERY LOCKING SYSTEM	C	C	C	C	C	C	C	C	C	C
LITIUM-ION BATTERY	C	C	C	C	C	C	C	C	C	C
BATTERY CONNECTOR	C	C	C	C	C	C	C	C	C	C
CHECKUP/INSPECTION	C									
ADJUSTMENT	A									
REPLACEMENT	R									

Maintenance time range reported in the maintenance table refer to a vehicle use under normal conditions.

Maintenance periods can be reduced, depending on the environment, weather conditions, riding habits and terrain.

Maintenance and inspection procedures can be performed and confirmed only by authorized dealer.

First maintenance intervention (month and mileage) is crucial and truly important for vehicle correct functioning.

## ERROR TABLE

ERR001	Motor failure	Switch off the scooter and call the assistance
ERR002	Hall sensore failure	Switch off the scooter and call the assistance
ERR003	Throttle failure	Switch off the scooter and call the assistance
ERR004	Motor controller unit failure	Switch off the scooter and call the assistance
ERR005	Battery failure	Switch off the scooter and call the assistance
ERR006	Push-button On/Off placed Off	Place the button in position ON
ERR007	High discharge temperature	Select map "E" and wait for the error to disappear
ERR008	Low discharge temperature	Outside temperatura is too low. Do not use scooter.
ERR009	High temperature of the charging batteries	Charging will not start until the temperature drops below the set threshold
ERR010	Low temperature of the charging batteries	The batteries have to be recharged in a warm environment
ERR011	Battery pack overvoltage	Riding the scooter for few kms and this error will disappear.
ERR012	Battery pack undervoltage	Enter map "E", recharge the battery as soon as possible
ERR013	Single Cell Undervoltage	Enter map "E", recharge the battery as soon as possible
ERR014	Single Cell Overvoltage	Riding the scooter for few km and this error will disappear. Please call assistance if persists
ERR015	High discharge current	Select map "E" and call the assistance.
ERR016	High charging current	Switch off the scooter and call the assistance
ERR017	Excessive Voltage Difference Between Battery Cells	Switch off the scooter and call the assistance
ERR018	Excessive Temperature Difference Between Battery Cells	Switch off the scooter and call the assistance
ERR019	Voltage sensor failure	Switch off the scooter and call the assistance
ERR020	Temperature sensor failure	Switch off the scooter and call the assistance
ERR021	Bms over temperature	Switch off the scooter and call the assistance

## CHECKUP AND MAINTENANCE

### IN CASE OF FAILURE

In case of any kind of problem or irregularity during the vehicle utilization keep immediately contact for a **WOW** assistance workshop, where you will find genuine spare parts, available to ensure your scooter a level of suitable quality (in addition on maintaining the validity of guarantee).



## ACCESSORIES UTILIZATION WARNINGS

### Accessories and modifications

Adoption of non-original vehicle **WOW** accessories or modifications can adversely affect on scooter safety and functioning.

**WOW** assumes no burdens regarding non-original accessories choice, installation and utilization.

In case of accessory installation make it sure that:

- It does not cover lighting equipment,
- It does not reduce vehicle ground clearance or its inclination angle,
- It does not hinder suspensions free movement,
- It does not prevent a correct riding position,
- It does not interfere with the utilization of any command.

We recommend to dedicate most attention to any accessories fixing, and not to exceed the maximum permissible load established by **WOW**.

It is further recommended do not remove any of the original components and do not alter the vehicle in any way, since such modifications could lead to maneuvering issues, vehicle stability and braking, as well as making it no longer suitable to circulation on public roads.

Specifically, drive very carefully in case your scooter is equipped with a windshield: the latter generates aerodynamic forces that can affect on vehicle stability.

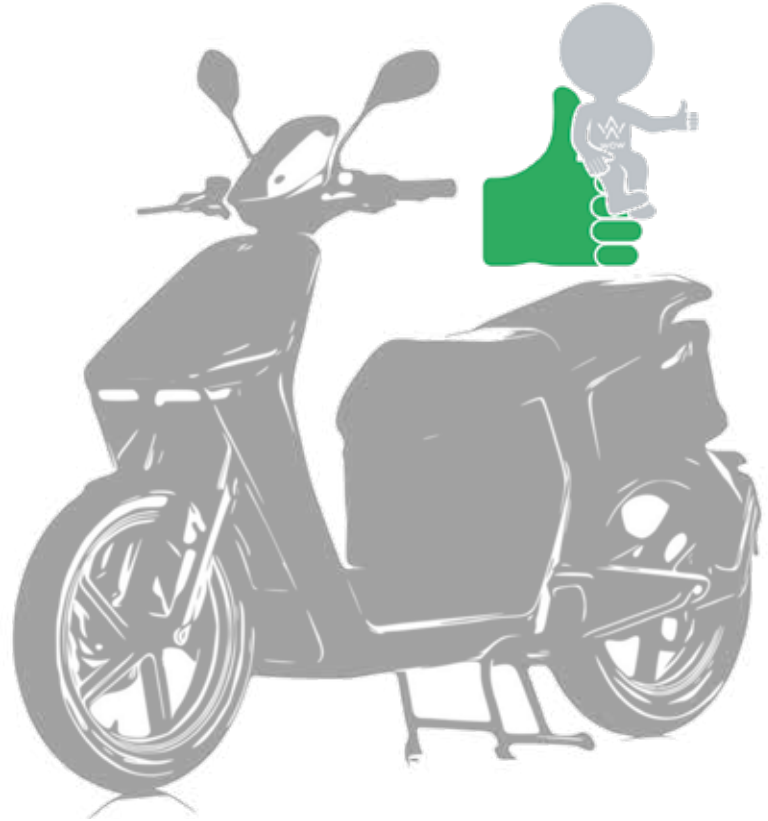

Analytical Index	Page
Throttle: Control	35
Throttle: Utilization	19
Accessories and Modifications	45
Rear Shock Absorber: Control	36
Scooter Start-Up	18
Horn	12
Batteries: Verification	22
Batteries: Recharge	23
Batteries: Warnings	26
Steering Lock	11
Ignition Lock	11
Battery Charger	24
Load / Luggage	30
Central Stand	15
Side Stand	16
Belt Drive: Verification	34
Errors Table	43
Handlebar Electric Controls	12
Direction Indicators Control	12
Odometer	12
Pre-Drive Checkup	34

Analytical Index	Page
Brakes: Adjustment and Controls	36
Brakes: Combined Braking (WOW 775 Model)	20
Brakes: Utilization	20
Bag Hook	14
Light Equipment	12
Periodic Maintenance Table	42
Vehicle Identification Number (VIC)	5
Parking	33
Wear Brake Pads: Verification	37
Tires: Verification and Pressure Check	39
Passenger Footrest	17
5V Socket	14
Electric Control Buttons	12
Vehicle Description	6
Dashboard Controls: Functions and Meanings	10
Steering: Verification	35
Dashboard	9
Speedometer	9
Remote Control – Keys	8
Undersaddle Compartment	13



WOW

wowescooter.com

